



Amplified Inductive Sensors Ø 8



AMPLIFIED INDUCTIVE SENSORS INCREASED RANGE 10÷30 VDC 3 WIRES NPN OR PNP OUTPUT

- Three-wire sensors
- Increased range, shielded, not shielded
- Range, 2 mm to 3 mm
- Short housing models
- 200mA NPN or PNP
- Operation LED
- Cable or M8 and M12 quick connect models

IS Series



Identification code

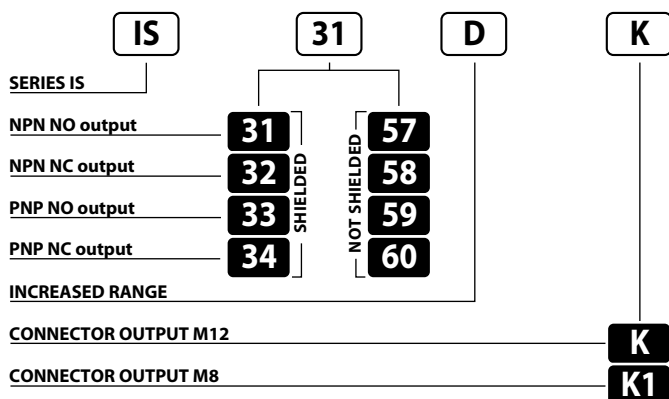

Wiring diagrams

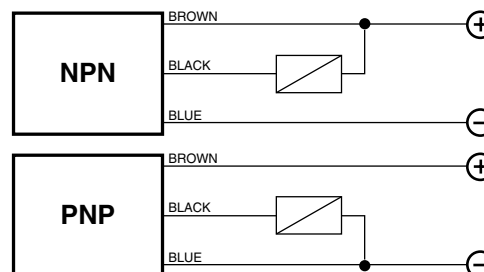

Connection with connector M12 (K)

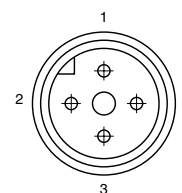

View of quadripole male connector.

CONFIGURAZIONE CONTATTI

Available	Contacts numbers			
	1	2	3	4
(NO or NC)	+		-	NO/NC

Connection with connector M8 (K1)

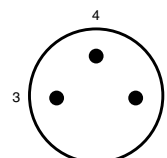

View of tripole male connector.

CONTACTS CONFIGURATION

Available	Contacts numbers		
	1	3	4
(NO or NC)	+	-	NO/NC

	SHIELDED	NOT SHIELDED
NOMINAL SWITCHING DISTANCE (S _n)	2 mm	3 mm
NOMINAL VOLTAGE	10 ÷ 30 VDC (-15 / +10%)	
RESIDUAL RIPPLE	≤ 10%	
HYSTERESIS	< 10%	
MAX. OUTPUT CURRENT	200 mA	
RESIDUAL CURRENT	< 10 mA	
VOLTAGE DROP (Sensor ON)	< 1.2 V (I = 100 mA)	
OPERATION LED	Yellow	
SWITCHING FREQUENCY	500 Hz	
START UP DELAY	≤ 75 mS	
REPEATABILITY	≤ 3%	
SHORT CIRCUIT PROTECTION	Present (self-resetting)	
ELECTRIC PROTECTIONS	Against polarity reversal - inductive loads	
TEMPERATURE LIMITS	- 25 ÷ +70 °C	
PROTECTION DEGREE	IP 67	
CABLE LENGTH	2 m	
CABLE SECTION	3 x 0,14 mm ²	
HOUSING MATERIAL	Nickel-plated brass	
WEIGHT - Cable output -	80 g	
WEIGHT - K1 connector output -	40 g	
WEIGHT - K connector output -	55 g	

Dimensions (mm)

CONFIGURATION WITH CABLE

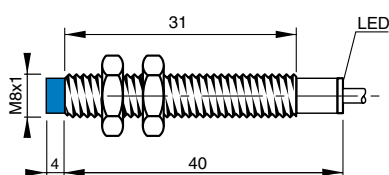

CONNECTOR K

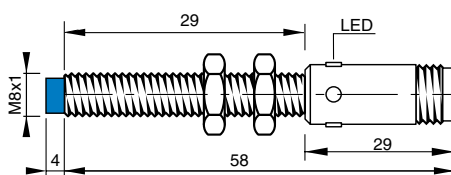

CONNECTOR K1

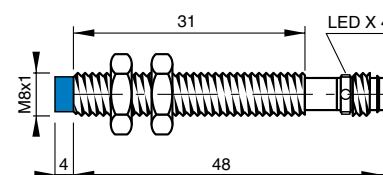

Note: the front part in blue refers to not shielded models

INCREASED RANGE